

WHITE PAPER

Solutions for EMP/EMI protection in Control rooms/-centers in critical infrastructure

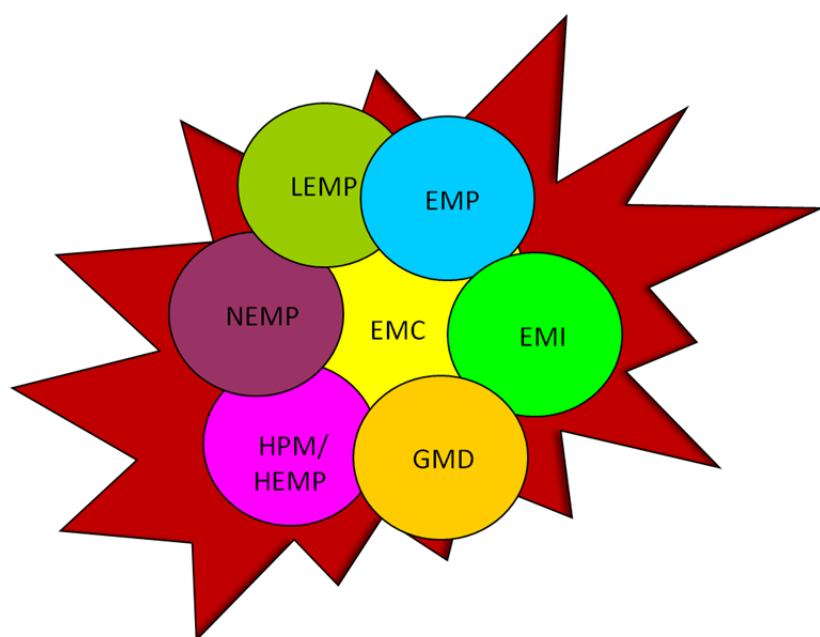

Espen C. Brantzeg

 **EB** CONSULTING AS



WHITE PAPER

Solutions for EMP/EMI protection in Control rooms and Control centers in critical infrastructure

Prepared for; Roxtec International AB

Author; Espen Cappelen Brantzeg

Published; 2015-05-18

© Copyright 2015/EB Consulting as



ADVISORY CONSULTANT TELECOM, EMP AND SCADA

Lian Platå 51, N 4638 Kr.sand, Norway

Mobile +47 90678148

Email: post@eb-c.no

Web: eb-c.no

Index	Page
1. Abstract.....	4
2. Introduction.....	5
2. Definitions, threats and implications.....	5
3. Critical infrastructure.....	13
4. Requirements and specs.....	15
5. EMP/EMI shielding construction and solutions.....	15
6. Verification, test and measurements.....	29
7. Construction, knowledge and competence	33
8. Documentation.....	33
9. Reference documents.....	33

Abstract

This White Paper is written to visualize and implement means to protect electronic equipment in critical infrastructure against Electro Magnetic Pulse and Electro Magnetic Interference (EMP/EMI).

The paper initially describes potential EMP/EMI threats; both man-made and natural. The two main threats; natural EMP (like solar storms and lightning) and man-made EMP (like HEMP, NEMP, RFW etc.) are presented and discussed as needed background information for planning of adequate protection solutions.

Finally the paper present recommended solutions and means to harden and protect actual components in civilian critical infrastructure against Electromagnetic threats.

1. Introduction

Based on the fact that a growing number of countries have developed or are in a process of developing different potential devastating EMP-weapons the need of sufficient and effective shielding solutions have been more demanding in order to protect electronic components and systems in critical infrastructure from breakdowns.

In addition, our knowledge about and decades of experience with critical failures and incidents caused by solar storms and the fact that electronic devices become more and more sensitive to "urban noise", compels us to protect vulnerably electronic equipment, devices and systems with highly effective shielding solutions.

2. Definitions, threats and implications

Here are listed some actual definitions and terms related to EMP/EMI etc. needed to understand the following chapters in this paper.

2.1 EMF = Electro Magnetic Field

- ✓ Combination of electric (V/m) and magnetic (μ T) field; dependent of voltage and current flow
- ✓ EMF is a general and common term representative for all the following topics in this chapter
- ✓ Sources;
 - Radio transmitters
 - Mobile phones and network
 - Power lines, transformers, generators etc.
 - In-house electrical network and household apparatus
 - Electric machines etc.

EMF with a certain field strength/flux can cause human injuries and damages or disruption of electronic devices.

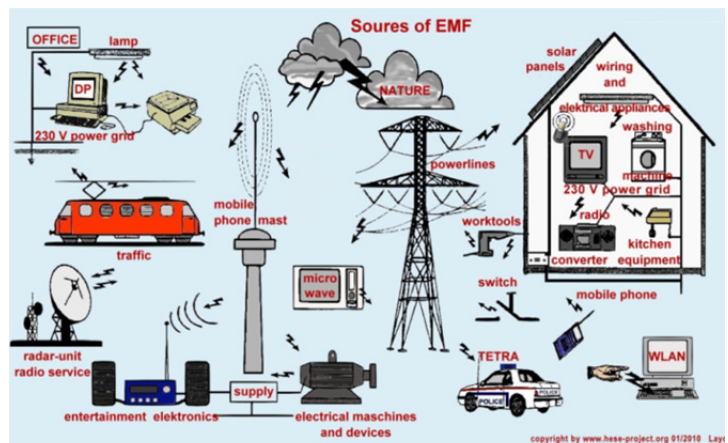

2.2 EMC = Electro Magnetic Compatibility

- ✓ A characteristic or property of electronic equipment to ensure problem free cooperation with other electronic equipment in the same electromagnetic (EMI) environment
- ✓ Avoiding unwanted interference effects due to induced unintentional generation, propagation and reception of electromagnetic energy between electronic devices



Note! To avoid some general misunderstanding; the term EMC is not equal to EMP/EMI!

2.3 EMI = Electro Magnetic Interference

- ✓ Radio-frequency interference (RFI) due to electromagnetic radiation or induction

EMI can cause degradation of electronic equipment functionality, performance degrading or worst case disruption and switch-off.

Some organs in the human being have shown to be sensitive and vulnerable to radiofrequency emission and electromagnetic interference.

Some typical EMI-sources;

- Wireless and radio&television broadcast transmissions
- Mobile telephones and wireless networks
- Industrial, scientific and medical equipment
- Digital processing circuitry; microcontrollers etc.
- Electrical welding equipment
- Ignition noise from motors etc., micro ovens
- Spark noise from electric power transmission
- Solar storm activity
- Northern Lights

2.4 EMP = Electro Magnetic Puls

- ✓ Radiated or conducted magnetic or electrical (high frequent) pulses and transient disturbances; short bursts pulses with high intensity (field strength) and energy

EMP can cause temporary or permanent switch-off and damage of electronic devices and equipment.

Some typical sources;

- Lightning (LEMP)
- EMP-weapons (HEMP/RFW/HPM etc.)
- Nuclear weapons (NEMP)
- Solar storm activity; geomagnetic disturbance (GMD)
- Northern Lights
- Electrostatic discharge (ESD)
- Power line surges

2.5 Some physical facts

The frequency spectrum related to the actual threats is from approx. 100 kHz to some 10's of GHz; in the non-ionizing part of the spectrum. See [fig. 1](#) below.

Fig. 1 | Actual frequency band for the EMP/EMI threats

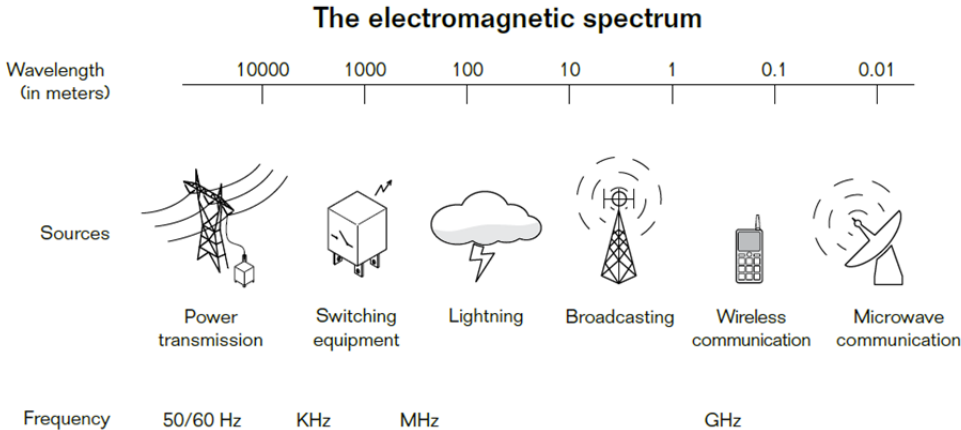

We can divide the spectrum in three main “components”; magnetic field (B), electric field (E) and plane waves. Electromagnetic waves can be imagined as a self-propagating transverse oscillating wave of electric and magnetic fields. [Fig. 2](#) below shows a 3D animation of a plane linearly polarized wave propagating from left to right. The electric and magnetic fields in such a wave are in-phase with each other, reaching minima and maxima together in the same points in space.

Fig. 2 | Electromagnetic plane waves

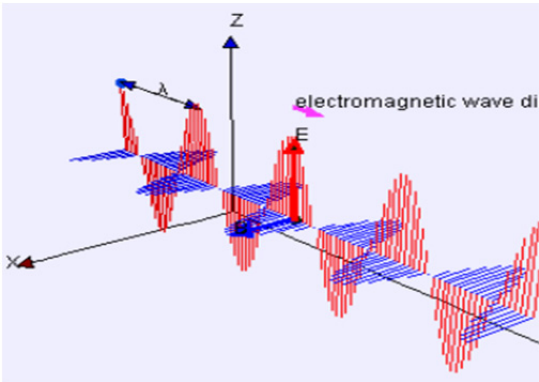

Electrical field strength vs. frequency

The EMP field normally decreases significantly with increased frequency; as shown in [fig. 3](#) below.

Fig. 3 | Field strength vs. frequency

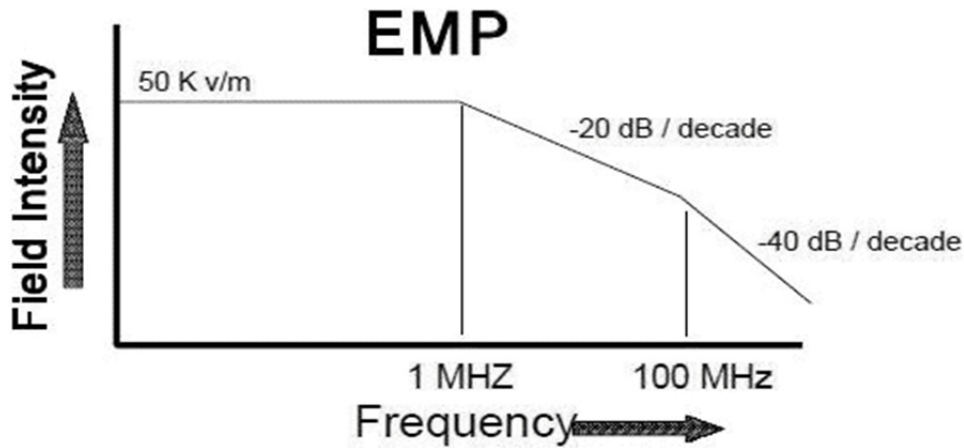

Typical EMP pulse waveforms

As shown in [fig. 4](#) under the EMP pulse form varies depending of pulse type. EMP-weapons (HPM, HEMP) normally have higher electrical field intensity and shorter duration than e.g. nuclear EMP.

Fig. 4 | Various EMP pulse waveforms

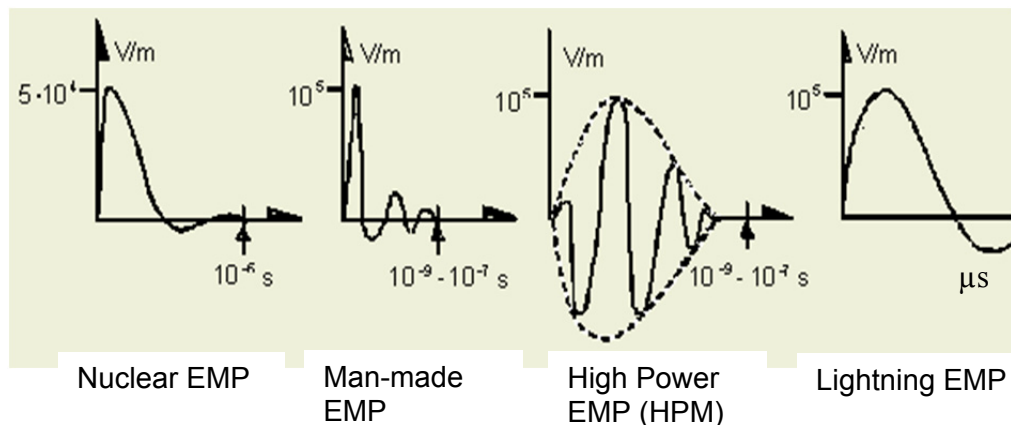

2.6 LEMP = Lightning EMP

- ✓ Relatively long-durating pulses (μs); $f =$ up to some 100MHz; very high energy in the lightning channel (typical $I=50\text{-}150\text{kA}$!)

LEMP gives disturbances, degraded operation or permanent damage of electronic devices in addition to fires and human accidents.

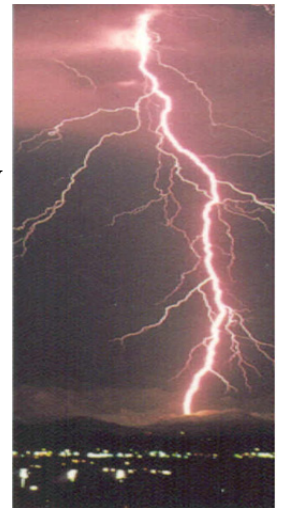

2.7 NEMP = nuclear weapons

- ✓ Very potent high frequency ($f \geq 1\text{GHz}$) very short pulses (ns) radiation from landbased or airborne nuclear bombs and missiles

Nuclear weapons give serious and permanent mechanical, thermal, ionizing (gamma radiation), medical and lethal effects.

The gamma radiation ionizing creates a huge electromagnetic pulse in three stages ($E_1\text{-}E_3$) when interacting with the Earth's magnetic field. These EMP pulses can cause serious temporary or permanent damage on electronic devices/ equipment/ circuits.

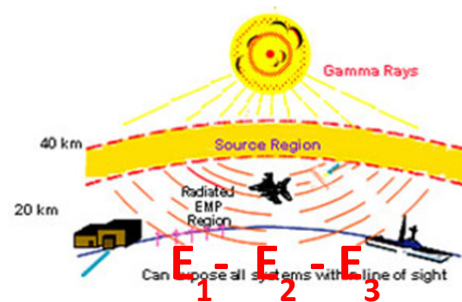

2.8 HEMP/RFW/HPM/NNEMP etc. = EMP-weapons

These weapons are divided in two groups; non-nuclear and nuclear as described previously. Non-nuclear are fairly weak compared with the nuclear ones (typically one million times weaker), but still capable to knock out electronic devices in regional or local areas. Below follow some common types of weapons and capabilities;

- ✓ HEMP is a very potent high energy/frequency ($f \geq 20\text{GHz}+$) ultra short pulses (ns) radiated from high-altitude EMP-weapons. See example on http://www.boeing.com/Features/2013/10/bds_cchamp_10_22_12.html
- ✓ HEMP weapons are a variation of the previous described NEMP weapon; special designed for exposing high emp energy with main purpose to destroy electronic devices and systems; more than causing material destruction and human injuries
- ✓ NNEMP generators (non-nuclear) as payload in bombs, missiles and drones for high altitude attacks

- ✓ RWF also called IEMI (Intentional Electromagnetic Interference) generators placed in vehicles or portable “suitcase” for short distance to target purposes
- ✓ Portable weapons are available on Internet (cost some \$10’s)

EMP-weapons will cause temporary disturbances, degraded operation or permanent damage in electronic equipment and devices (electronic circuits). The degree of damage depends on the weapon type, power, distance to target etc. Such weapons are non-lethal and give small or no mechanical, thermal or ionizing effects.

Below follows some additional information regarding the above described types of EMP-weapons.

2.8.1 HEMP

The EMP from a high altitude (hundreds of kilometers above Earth) nuclear burst (HEMP) consists of three components;

- E_1 pulse | a very short pulse (ns); lasting fractions of microseconds; generates a shock that instantaneously damages, disrupts and destroys electronic devices and systems over a very large area. The E_1 pulse couples effective to short and long cables /conductors, e.g. computer USB-cables, radio antennas, long-haul telecom lines and electric power transmission lines. The pulse is capable of causing upset, switch-off and burnout of electrical and electronic systems in general. E_1 will destroy important and critical control system e.g. SCADA for managing national infrastructure (electric grid, air traffic control, land based transport systems etc.). Stockpiling critical and vulnerable electronic components will be of great concern to be implemented in a restoration process!
- E_2 pulse | has effect similar to lightning and will also cover large areas (nations) in fraction of a second, but some degree later than E_1 , some micro-/milliseconds after detonation. Electronic systems and devices with built-in protection will most probably avoid serious damage, but synergistic effects can cause more damage than E_1 alone. Stockpiling critical components will be highly recommended!
- E_3 pulse | is a much longer pulse, up to several minutes duration. This type of pulse causes effects similar to those produced by intense solar storms/winds. It will induce and couple high electrical currents in very long grids, telecom lines and cables, pipelines etc. Critical and important grid components like EHV transformers, breakers, management control systems etc. will be seriously vulnerable! Due to normally long delivery time damaging of such big transformers will cause long-time electrical grid breakdown!
- In general E_1 and E_3 pulses are of greatest concern since each pulse effect has the potential to collapse national electrical grid and other systems consisting of large number of electrical components for long periods. This in turn will cause catastrophic damages and implications for nations and even greater

parts of continents! The combination and sequential timing of the three types of E's will give an accumulation of effects and cause far more damage than each one of the E's alone!

2.8.2 RFW, HEMP, NNEMP etc.

Less potent weapons like RFW will also cause serious damages on electrical systems and devices, but in less scale due to smaller effects and exposed on potential targets on much less distances.

On ground attacks with low powered portable weapons (RFW) will cause limited and local impacts. Local unprotected infrastructure, nearby data/control centers, vehicles, etc. will fail and break down; permanently or at least temporary.

On ground attacks with "bigger" E-bombs etc. (RFW, HPM, NNEMP) will cause extensive and regional damages. Majority of unprotected civilian infrastructure will fail and break down; permanently or at least temporary for a long time.

A HEMP weapon detonated some km above the earth's surface would destroy all electronic devices within a large targeted area!

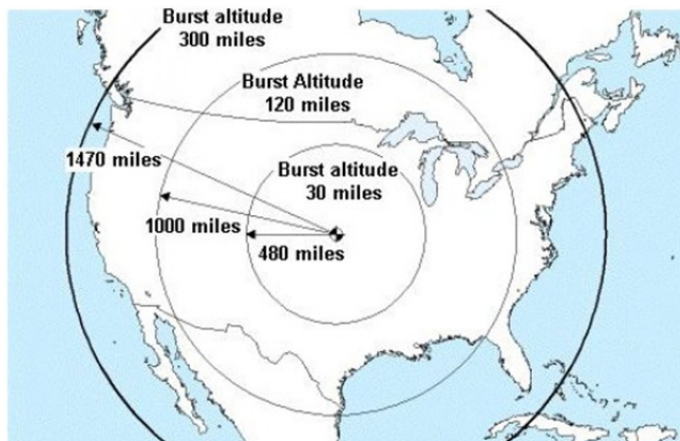
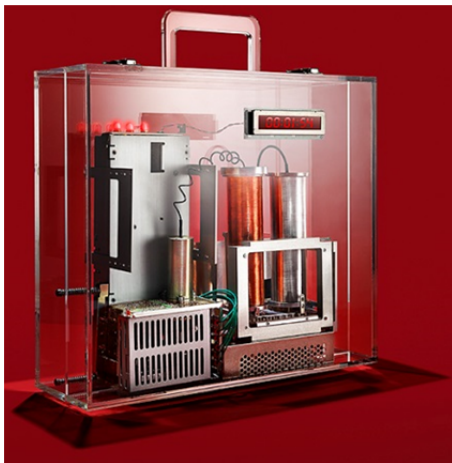

2.8.3 Some known historical events caused by NEMP/HEMP weapons

- ❑ US "Star Fish Prime", "Bluegill Triple Prime " and "Kingfish" tests; 1962 (NEMP)
 - ✓ High-altitude explosion; Nuclear warhead detonated in atmosphere
 - ✓ EMP-pulse damaged various types of infrastructure; hundreds of miles away
- ❑ Soviet "Test 184"; 1962(?) (NEMP)
 - ✓ Nuclear warhead detonated in atmosphere
 - ✓ EMP-pulse damaged various types of power and telecom infrastructure in Kazakhstan

2.8.4 "Natural EMP threat" | Solar/geomagnetic storms

- ✓ A geomagnetic storm; Corona Mass Ejection (CME); is a temporary disturbance of the Earth's magnetosphere caused by a solar wind shock wave and/or cloud of magnetic field which interacts with the Earth's magnetic field. This interaction will cause Geo Magnetic Disturbance (GMD)
- ✓ The GMD can produce a very damaging component E_3 like the same component of nuclear EMP threat (NEMP)!; as described previously
- ✓ Such storms/winds can generate high voltage/currents in electrical wires and grids due to induction
- ✓ Normal cyclic maximum solar storm level appears in cycles every 11 year
- ✓ Medium extreme level storms are expected to appear every 50 years; while very extreme levels are "forecasted" with a return period every 150 years
- ✓ Recently (2012-'13) was a high intensity period

Solar storms can cause serious damages or disruption of:

- Power lines (high voltage grid), transformers etc.
- Electronic systems; SCADA, surveillance, satellites, GPS-systems, broadcast etc.
- Radio- and telecom network
- Permanent or temporary outage or damages (hours/days/weeks)

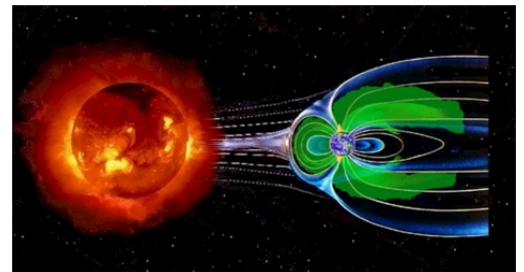

Some famous historical solar storms events;

- ❖ Carrington Event; 1859
 - Intense solar superflare (geomagnetic storm) in atmosphere impacted a great part of the Earth
 - Telegraph systems all over Europa and US failed and caused human injuries
 - A similar event today would cost the US alone \$1-2trillion!!
- ❖ A serious solar storm hit Canadian power lines; 1989
 - Ultimate strong electromagnetic field and EMP induced high currents in parts of the national grid
 - Result; disrupted all power lines and melted transformers in Quebec area; total blackout

- 6 mill people without electricity for weeks!!
 - Power supply to around 100 power plants and substations was interrupted
 - Some satellites got big problems with sensitive electronics and temporary cut-down
- ❖ Several solar storms in 2000, 2003, 2012
- Resulting cut-off/breakdown of electronic device in US, France, Mediterranean countries, Sweden etc.

3. Critical infrastructure

Critical infrastructure is the backbone of every nation's economy, security and health. We know it as the power we use in our homes, the water we drink, the transportation that moves us, and the communication systems we rely on to stay in touch with friends and family.

Critical infrastructure are the assets, systems, and networks, whether physical or virtual, so vital to the countries that their incapacitation or destruction would have a debilitating effect on security, national economic security, national public health or safety, or any combination thereof.

In the following some typical examples of critical infrastructure are listed; which are highly sensitive and vulnerable to EMP/EMI impacts;

- Electricity generation/production, transmission and distribution
- Electrical Grids and Smart Grid Systems
- Gas production, transport and distribution
- Process Industries
- Heating (gas, fuel oil, steam etc.)
- Telecommunication; network, transmission and control centers
- Mobile network; base stations and centers
- Data centers; data equipment, control centers, power supply, cooling etc.
- Transportation systems (fuel supply, railway network, airports, harbors, inland shipping)
- Financial services (banking etc.)
- Agriculture food production and distribution
- Water supply (drinking water, waste water/sewage, stemming of surface water (dikes and sluices)
- Public health (hospitals, ambulances)
- Security services (police, military)



Most infrastructures have data/telecom systems highly dependent of critical electronic systems and equipment including power systems, cooling, vents. etc.



Data-, telecom-, process-, power systems, modern vehicles etc. have vulnerable electronic devices, processors etc. highly sensitive to electromagnetic “noise” like EMP and EMI etc.

Non-protected systems and equipment have high possibility for break-down; permanent or temporary after an EMP-attack/event.



Satellite systems can be hit by EMP (Solar storms, NEMP explosion etc.) and indirect cause massive problems for various transportation and telecom systems; air- and ships traffic, on-land transportation, mobile phone network etc. The drawing [fig. 5](#) below shows the most critical infrastructure systems and their dependence in a modern society. [Fig. 6](#) below shows relevant possible impacts on critical infrastructure when exposed from various types of “noise” like EMI and EMP.

Fig. 5 | Modern infrastructures and interdependence

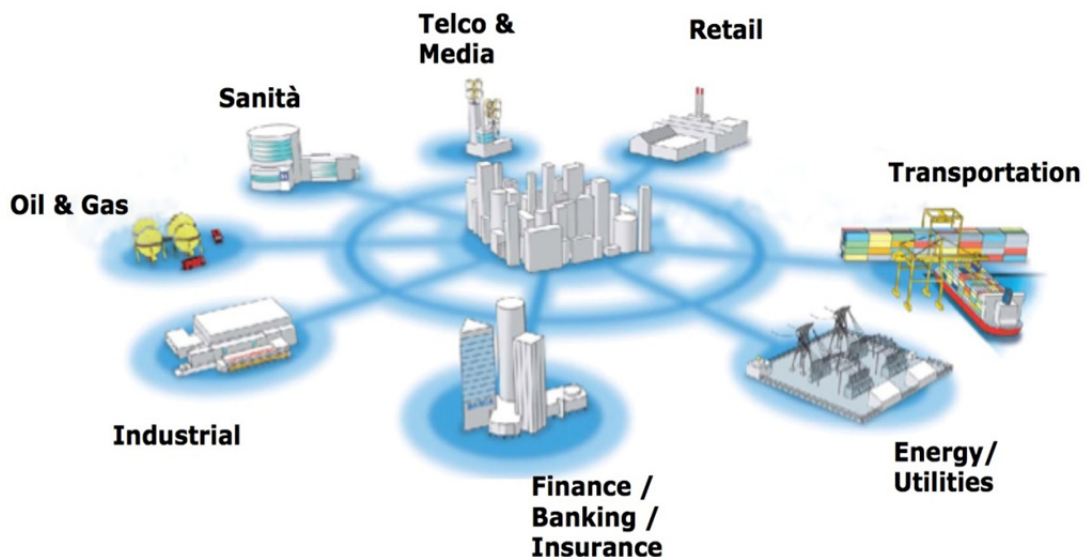
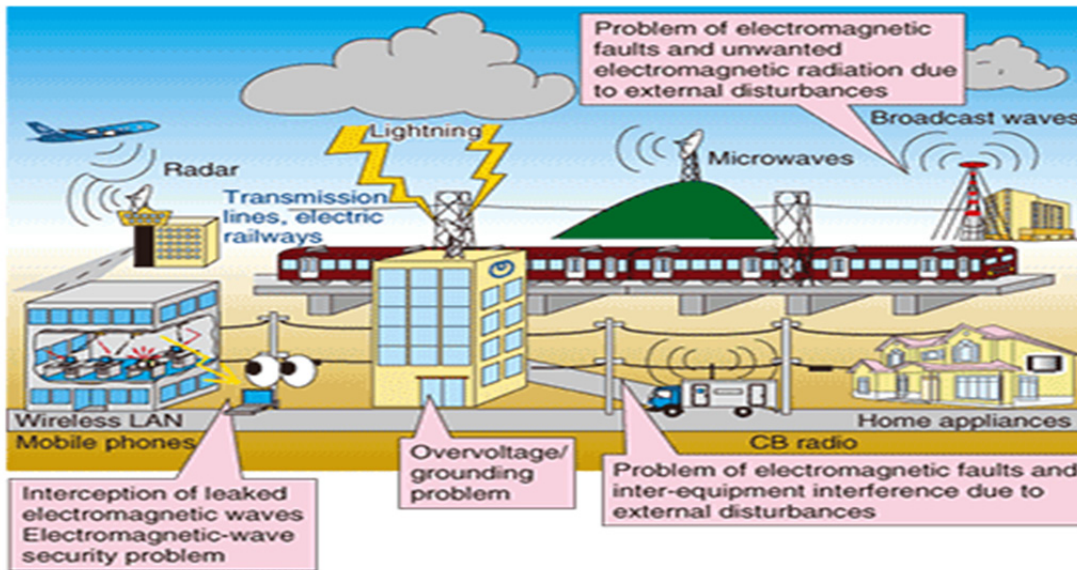

Fig. 6 | Possible impacts on critical infrastructure when exposed from EMI/EMP



4. Authority protection requirements and specs

The regulatory requirements for protecting vulnerable electronic devices and system against EMP and EMI in critical infrastructure are normally determined by national authorities for civilian (and military) system.

The protection requirement (shielding effectiveness) defines a minimum needed attenuation of an EMP/EMI pulse within a certain frequency band; to ensure that the exposed pulses are kept under a critical limit to avoid damages.

The protection requirement varies from country to country, but in general a typical spec is approximately 40dB in a certain frequency band from LF (magnetic field) up to some 10's of GHz (plane waves).

In some countries; among them Norway; the Norwegian Water Resources and Energy Directorate (NVE) has given regulations and requirements for EMP/EMI protection of critical electronic systems like power and grid operational control (SCADA-systems), telecom etc.

5. EMP/EMI shielding construction and solutions

5.1 General

There are mainly three principal methods of protecting vulnerable electronic devices from a damaging EMP/EMI attack and natural EMP events;

- i) Put equipment in a shielded room based on Faradays Cage principles
- ii) Hide it deep into mountain plants or underground bunkers
- iii) Place it in the center of a solid building behind thick reinforced concrete walls and roof; primarily under ground level

The first alternative normally gives necessary protection assuming correct and satisfactory construction; described in later chapters.

The protection effectiveness in a mountain plant or bunker depends of several factors like type of rock and soil, degree of coverage, cable length, protection devices like gates and other barriers in front of the tunnel etc. This will be more elaborated in a following chapter.

The last alternative iii) gives only a limited degree of protection and is normally not sufficient unless it is combined with additional solutions; like alternative i).

5.2.1 Shielded Rooms/Faradays Cage

A Faraday cage or Faraday shield is an enclosure formed by conductive material or by a mesh of such material. Such an enclosure blocks external static and non-static electric fields by channeling electricity through the mesh, providing constant voltage on all sides of the enclosure. Since the difference in voltage is the measure of electrical potential, no current flows through the shield. Faraday cages are named after the English scientist Michael Faraday, who invented them in 1836. Fig. 7 below shows a principal drawing of a Faradays Cage.

A Faraday Cage operates because an external static electrical field causes the electric charges within the cage's conducting material to be distributed such that they cancel the field's effect in the cage's interior.

The Cage's metallic surface mainly absorbs and reflect exposed electromagnetic energy and leads the current via the grounding connection to the buildings earthing bar. See fig. 8 below.

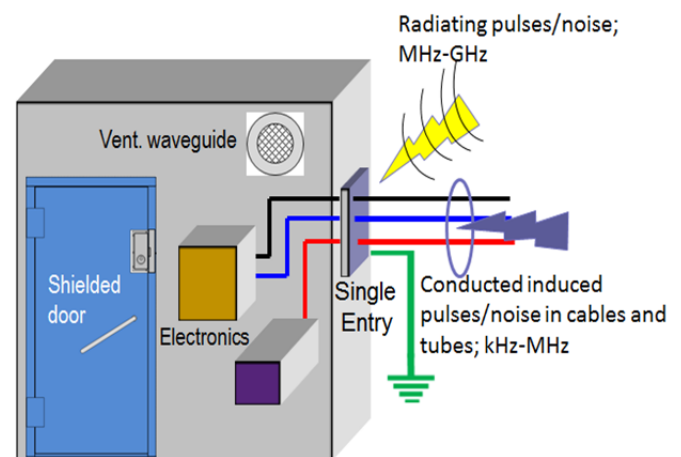

Fig. 7 | Faradays Cage

The Faradays Cage is the main principle method to protect electronic equipment from lightning strikes, electrostatic discharges and EMP/EMI.

Faraday Cages cannot block static or slowly varying magnetic fields, such as the Earth's magnetic field (a compass will still work inside). To a large degree, though, they shield the interior from external electromagnetic radiation if the conductor is thick enough and any holes are significantly smaller than

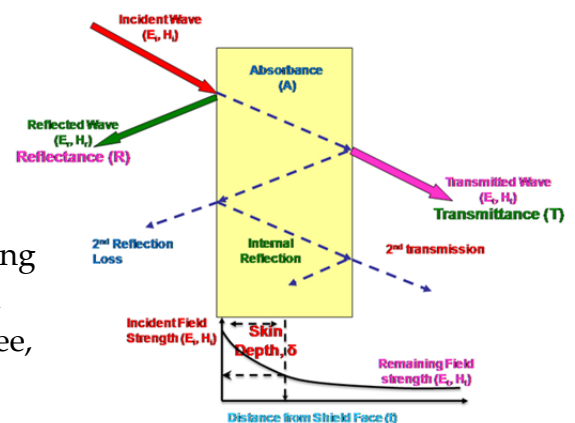

Fig. 8 | EMP/EMI absorption & reflection in a FC

the wavelength of the radiation. For example, certain computer forensic test procedures of electronic systems that require an environment free of electromagnetic interference can be carried out within a *screened room*. These rooms are spaces that are completely enclosed by one or more layers of a fine metal mesh or perforated sheet metal. The metal layers are grounded to dissipate any electric currents generated from external or internal electromagnetic fields, and thus they block a large amount of the electromagnetic interference.

5.2.2 Shielded room

An ideal Faradays Cage or a shielded room is a sort of a metal box without any openings; but in practical life we need some openings for entering the cage/room, cable duct, and openings for vent and cooled air etc.

Room construction

Shielded rooms are constructed in two optional solutions;

i) Prefabricated/ modular room with prefabricated 1-2mm steel plate elements which are collected and assembled on site with EMP-gaskets between all elements. This type gives very high attenuation and shielding effectiveness; typical 70-80dB@20GHz

ii) So called "Thin plate" construction; on site built shield with commodity thin steel plates covering all room surfaces. This type gives fairly high attenuation and shielding effectiveness; typical 50-80dB@20GHz



Fig. 9 below shows typical shielding effectiveness vs. frequency for a prefabricated enclosure.

Both types of construction comply with most common regulatory attenuation requirements for civilian purposes.

The shield itself must as initially described, be constructed of some type of electric conductive material. Normally thin galvanized steel plates are used, but

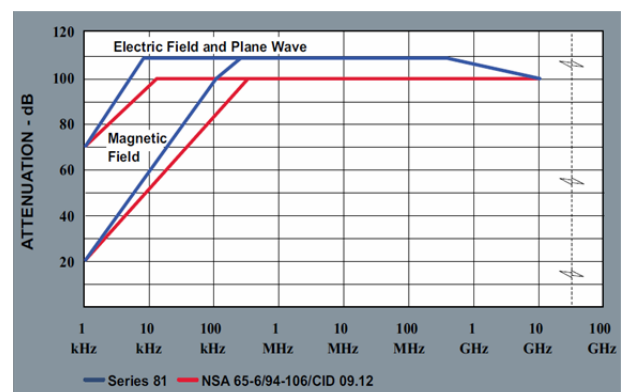

Fig. 9 | Shielding effectiveness in a "high class" enclosure

in some cases also other metal like copper or brass foil are applicable.

Doors

Doors in this type of shielded room are special designed with high EMP/EMI attenuation performance. The door frame and leaf have a special EMP gasket for sufficient coupling and good sealing effect.

There are in principal two different types of such doors;

- i. High performance door with knife frame and copper finger gasket. Typical shielding effectiveness 100dB@20GHz
- ii. A slightly less robust door with only a mesh gasket on the door leaf. Typical shielding effectiveness 45dB@20GHz

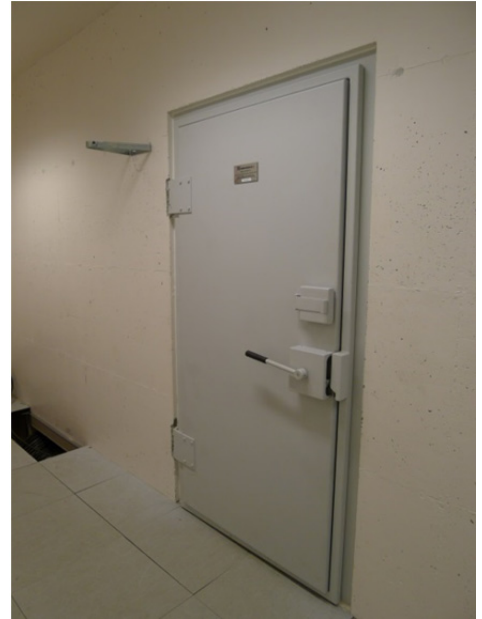

Photos on this side show examples of a typical EMP-gaskets; mesh and knife/finger.



Single Entry

All cabling and eventual tubes for cooling system are normally fed through the shield in one cable duct; called Single Entry. In some cases due to doubling and redundancy requirements the "single" entry is expanded to double or triple entries.

With minimization the number of cable entries to one or a few we keep control of the cabling structure. In addition we avoid unwanted feedthrough of random

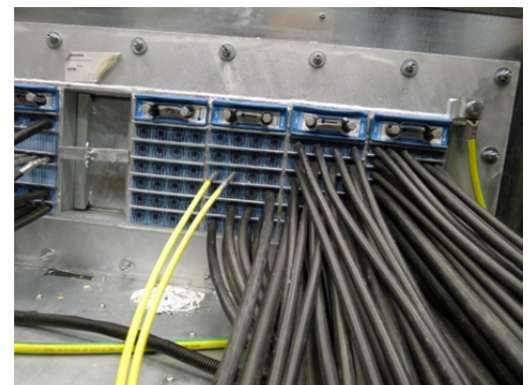

installed cabling; which can cause LF/HF leakage and worst case circular currents in the shield.

There are in principal two types of Single Entry;

- i. Modular Systems with Solid regular frames with sealing modules for cable feedthrough (fig. 10). Typical shielding effectiveness 50-70dB@20GHz
- ii. Cable glands with mesh tube sealing; mounted direct on the shield wall. There are in principal two types with different performance; a MIL grade with typically shielding effectiveness 70-80dB@20GHz, and industrial EMC glands with typical shielding effectiveness approximately up to 40dB@20GHz



Fig. 10 | Roptec Single Entry EMC

Photos on this side show some examples of Single Entry based on Roptec's modular Single Entry EMC and cable glands (industrial EMC and MIL grade) from other suppliers.

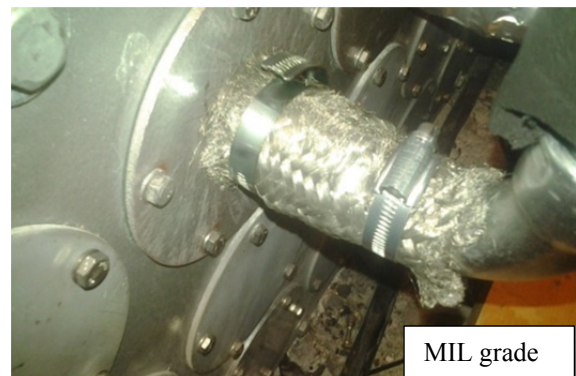
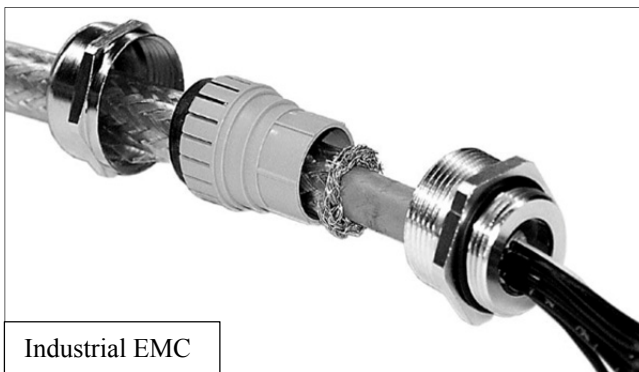

Fire and IP/water/moist protection

In addition to the described requirements related to EMP/EMI protection of electronic devices in shielded rooms and similar enclosures national authorities and customers in several countries also requires protection solutions against fire and water and moist intrusion. Typically fire resistance requirement for building construction including doors etc. is Fire-resistance Class EI60 ^{Note 1} or similar; also valid for enclosures housing processing data and telecom equipment. That means that also similar demands are valid for some of the actual elements in such enclosures; like shielded doors, Single Entries, air waveguides etc.

As an example some of the shielded doors available in the market do not comply with the mentioned fire-resistance class requirements. This is often solved with a second fire door in front of the shielded door to obtain both EMP/EMI and fire protection. See photo here.



Regarding fire and water resistance requirements for Single Entry equipment some of the manufacturers; among them Roxtec; have solutions which comply with the mentioned requirements and classes.

Note 1 Fire-resistance Class; a fire separation building component (e.g. fire door) made to EI60 should be able to prevent the spread of both heat and smoke gas for 60 minutes.

Cabling in Single Entry

Electrical cables

All electric cables must be shielded when installed through the shield/Single Entry! This is an absolute requirement! Unshielded cables penetrating the shield will act as unwanted antennas and destroy the shield effectiveness. Such no-shielded or poorly shielded cables will cause serious leakages and damages of the internal installed equipment in the shielded room!

There is a great variation of high quality and also less recommended cables in the market! Some manufacturers advertise and promote shielded cables as "EMC" without informing that some of these are not recommended for EMP-protection; thus revealing lack of competence on this topic.

Double dens braid/mesh shield or mesh/foil shield is highly recommended! See examples in [fig. 11](#) on the next pages.

Fig. 11 | Examples of poor and recommended/good cable shields

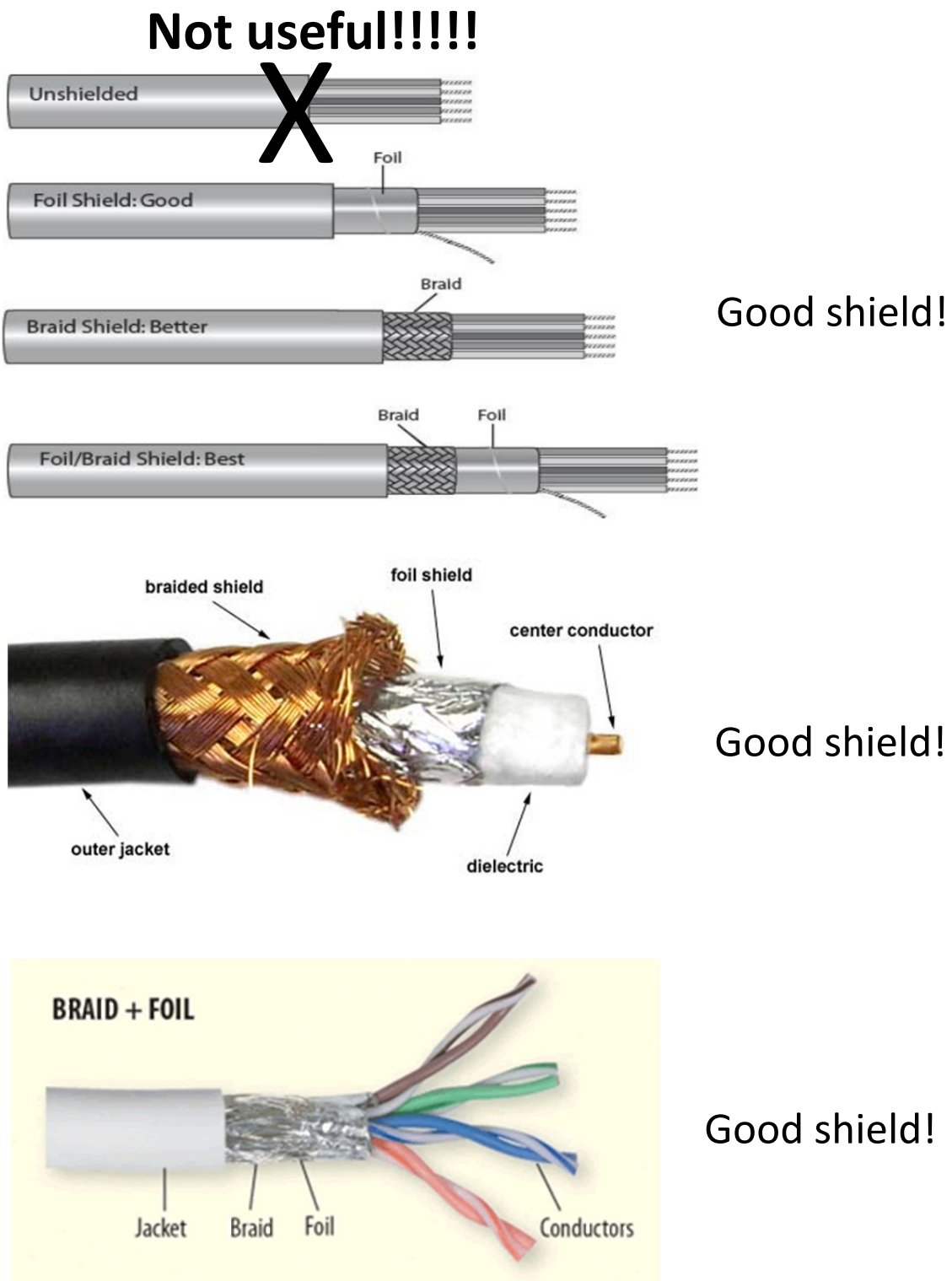

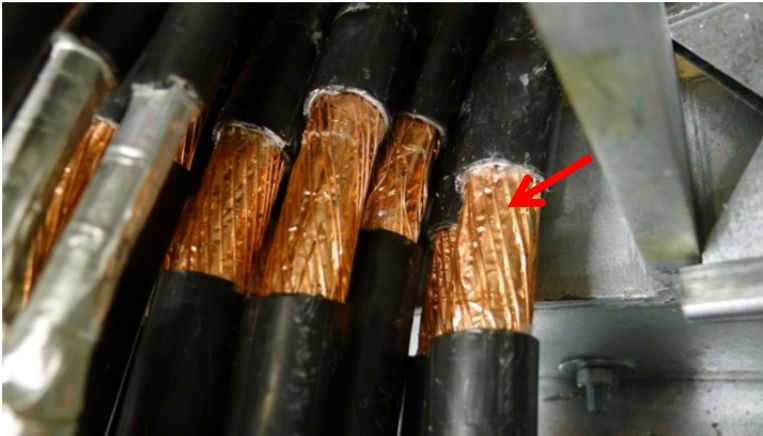

Good shield!

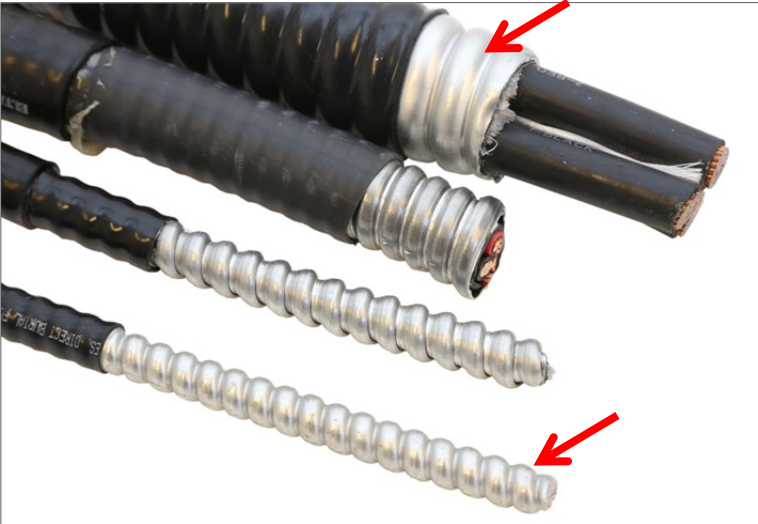

Good shield!

Remarks; corrugated cables with the continuous welded type of armor (see red arrows) provide a good shield; while the interlocked design (middle cables) is less good.

Good shield!



Poor shield!

Fiber optical cables

Fiber optical cables with cable jacket dimension $>$ than a critical limit (frequency dependent) must be mounted in Single Entry with a waveguide made of metallic tape or an extra mesh cable sheath. See photo below.

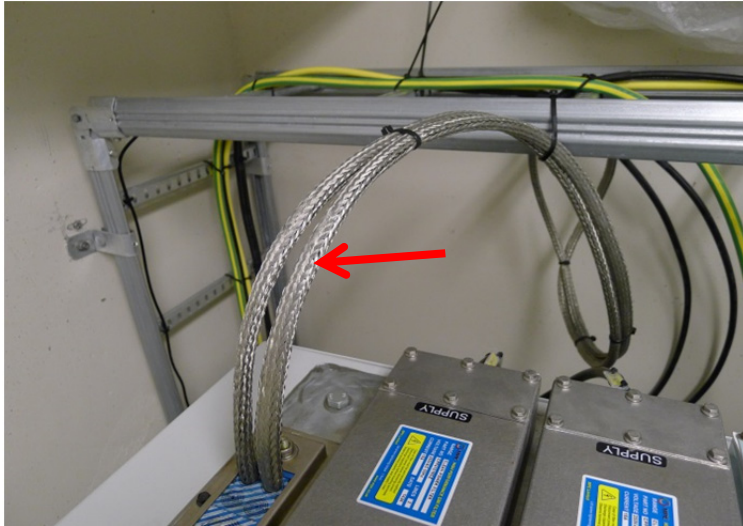

Cable filters

Cable filters give extra protection against induced transversal EMP-pulses. Filters normally are needed when extra high shielding effectiveness is demanded.

Normally low-pass and pass-band filters are used.

The filters are installed on the outside of the enclosure; close to Single Entry; direct on the shield wall. Typical attenuation performance for a power filter is 100dB from 10kHz. here. See photos on this page.



EMP shielding Air vent panels

The EMP shielding vent panels consist of either a rectangular or a circular frame with a honeycomb structure inside. The honeycomb vent is series of hexagonal "tubes" that acts as a waveguide, guiding electromagnetic waves in/out of the shielded room and blocking the airflow. Typically the tube L/W dimension should be 5:1 to obtain good performance effectiveness. The airflow is led nearly unobstructed



through the honeycomb while the electromagnetic pulses are stopped effectively. Typical shielding effectivity is approximately 80-100dB@20GHz. The photos on previous page and here show typical air vents. with honeycomb.

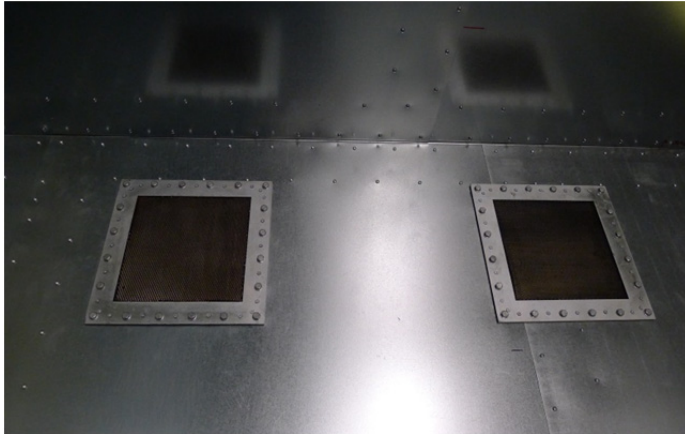

5.2.3 Shielded racks/cabinets

Shielded racks are in principal small Faradays cages. There are two different types of such cabinets;

- i. Rugged high performance steel racks with knife/copper EMP-gasket in the door. This type is normally also supplied with cable filters (power and telecom) in addition to the standard equipment like a small Single Entry, honeycombs and fans for vent. air. Typical shielding effectiveness is 50-80dB@ 18GHz
- ii. Semi rugged high performance steel racks with a more simple (less dens) mesh EMP-gasket in the door leaf. Like the type this is also normally equipped with filters in addition to Single Entry, vent honeycomb etc. Typical shielding effectiveness is 40-75dB@3GHz; with a significant lower upper frequency limit.



The graph; [fig. 13](#); below shows test results for a class 3 Cabinet (100kHz-18GHz) tested on site with cables in filters and Single Entry.

Fig. 13 | Cabinet on site test results

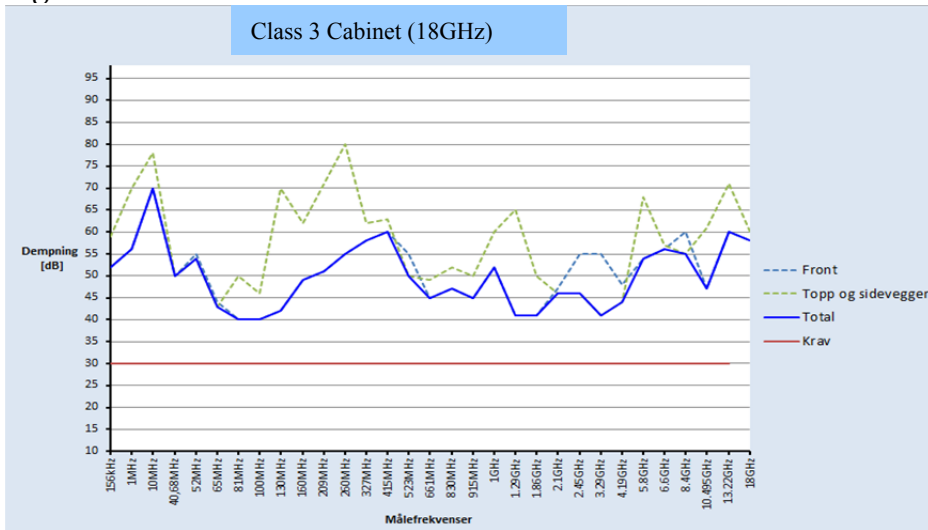

EMP-racks are expensive, but affordable compared with shielded room cost for a limited number of equipment to be installed. Assembly of cabinets is obviously much easier and cheaper than mounting shielded rooms. The enclosed photos show various types of floor racks and smaller racks for wall mounting.



5.2.4 Shelter/container

An EMP-container or shelter is a bigger Faradays Cage; steel box; built with approx. 3-5mm thick steel plates. Such containers are normally equipped with a shielded door, air vents with honeycomb, a Single Entry, cable filters etc. The shielding effectiveness is very high; often equal or better than shielded rooms; typical 70-80dB@18GHz. This solution is normally fairly expensive, but affordable when there is lack of in-house space.



5.2.5 Grounding of shielded rooms and cabinets

Grounding or earthing of electric systems and equipment has several meanings, definitions and purposes;

- Protecting earthing | protecting people to prevent user contact with dangerous voltage if electrical insulation fails, circuit potential reference, equipotential bonding/ interconnection to obtain equal voltage between circuits preventing dangerously currents floating between them etc.
- Functional grounding | normally the neutral in an electrical power supply system, reference level for surge suppressors and EMP/EMI filters; interconnection is also a sort of functional grounding

For shield EMP/EMI shielded rooms and cabinets the grounding “network” is most essential for obtaining good shielding effectiveness. Thus the shielding main purposes; EMP and EMI *absorption and reflection*; are fully dependent of a correctly grounded shield.

Since the grounding systems main task is to conduct and drain possible unwanted currents in a wide frequency band from DC up to several GHz; the grounding topology is of great importance! Normally the shield is connected with a massive grounding cable connected to the main earthing bar in the building and to the grounding rod outside on the Single Entry. It is essential that the grounding resistance is low in the connection point in the building; that means low soil resistance (typical some few Ω 's). The coupling resistance between the Single Entry frame and the shielded room must be even better! Recommended value is $< 1\text{m}\Omega$. As an example; Roxel EMC systems are designed for a coupling resistance even better; typically less than $1\text{m}\Omega/\text{DC}$ and impedance better than $10\text{m}\Omega / 30\text{MHz}$.

Fig. 14-15 below shows the principle grounding of a shielded room and cabinet itself and internal grounding and bonding network for technical equipment inside the room/cabinet.

Correct grounding shall provide equal potential levels both on outside and indoor in the shielded room/cabinet. Thus avoiding unwanted current loops in the shield itself and between the inside equipment.

Fig. 14 | Principal drawing of the shielded room grounding system

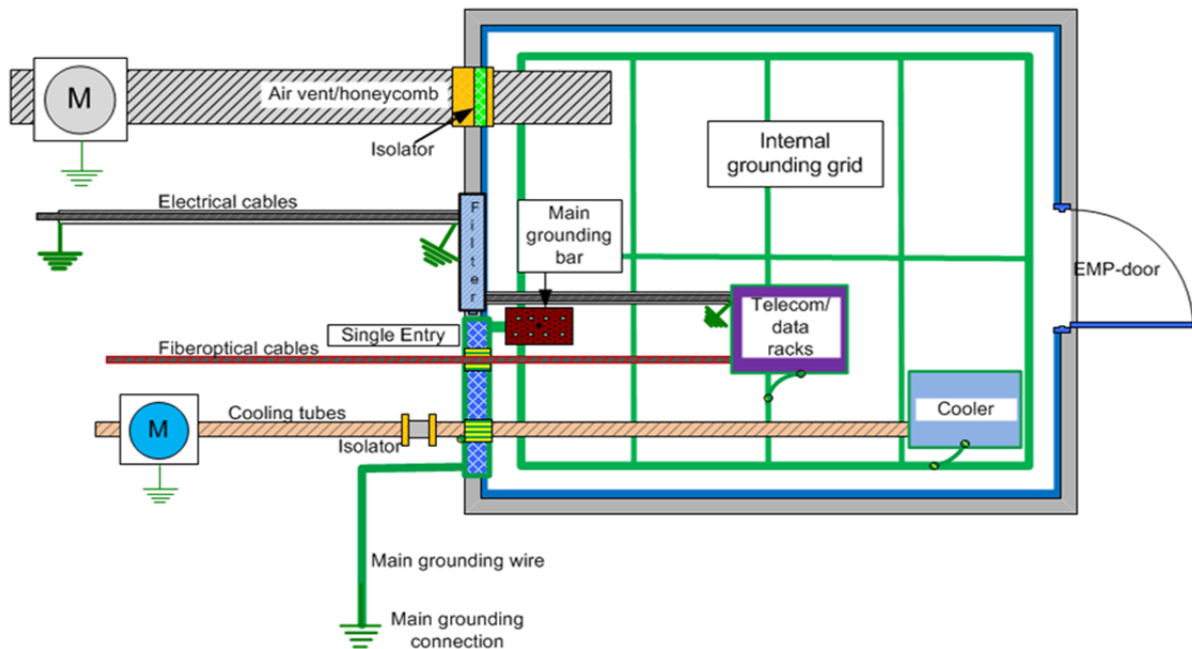
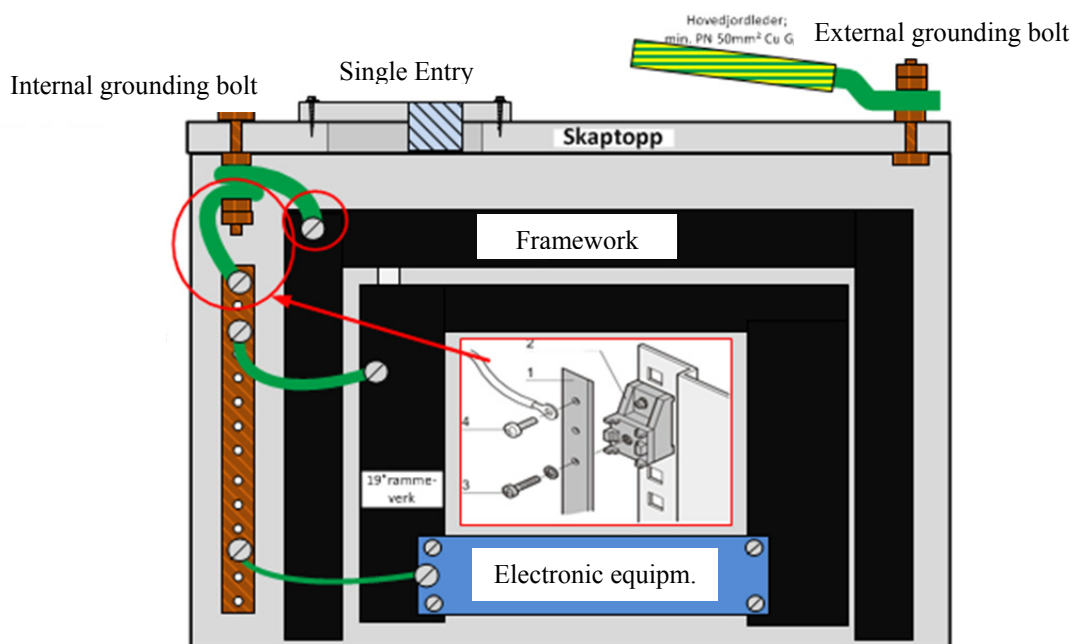

Fig. 15 | Principal drawing of the cabinet grounding



5.3 Operation and Preventive Maintenance (MOM)

The shielded enclosures and cabinets have to be regularly maintained to ensure specified shielding effectiveness. Typical maintenance activities are:

- General inspection and eventually repair of holes, slots and other irregular openings in the enclosure metallic structure
- Cleaning, lubrication and greasing of EMP-gaskets (valid for knife/Cu-finger) doors
- Checking possible EMP-gasket damages (broken Cu-fingers, damaged knife etc.)
- Door lock gear inspection and adjusting
- Air vents (honeycombs) dusting and vacuum cleaning
- Single Entry frame and modules inspection
- Filter inspection and fixing bolts tightening
- Grounding and bonding cables inspection and tightening bolts, cable lugs etc.

The maintenance frequency depends among other type of doors, frequency of use etc. Typically such enclosures have to be inspected once or twice a year.

Normally the supplier of a complete enclosure prepares a MOM document containing check lists for the above describes maintenance activities.

5.4 Mountain Plants/Underground Bunkers

Vulnerably electronic equipment could be effectively protected even without extra shielding in a Faradays Cage, if it is placed deep enough inside in a mountain plant or underground bunker. The shielding effectiveness is in that case dependent of some important preconditions related to;

- Rock and soil environment depth and thickness; i.e. the insertion loss massive EMP attenuation. See [fig. 16](#) below
- Rock and soil type; i.e. the ground conductivity. See [fig. 16](#) below
- Cables from outside into the mountain; types, length; i.e. cable total attenuation for various actual frequencies (100kHz-18GHz)

Fig. 16 | Typical soil/ground/rock attenuation vs. actual frequency range

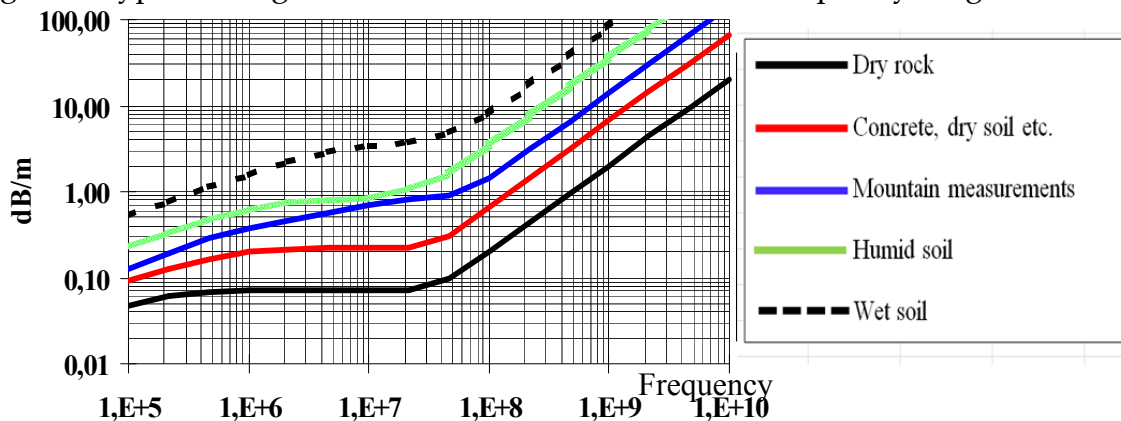

In addition to the rock thickness and conductivity the total cable attenuation along the entrance tunnel determines the total mountain plant EMP attenuation effectiveness. The cable attenuation is dependent of cable shield, wire dimension and total cable length as a function versus frequency. As the attenuation is proportional to the square of the cable length and frequency, the impact of the EMP is most critical for low frequencies; i.e. from kHz up to some MHz. The cable conductivity for higher frequencies; GHz; will normally be negligible.

5.5 Other physical barriers and protection solutions

In addition to the previously described solutions for dedicated EMP/EMI protection with enclosures there are other methods to obtain physical protection and robustness to avoid or withstand sabotage and reduce damage.

Especially for low power EMP-weapon with limited range (handheld, suitcase RFW) physical distance between the weapon carrier and the target is vital; as a means in addition to the EMP-shielding. Typical such means are gates, fences and other robust barriers placed in sufficient distance from building containing vulnerable electronic devices.

6. Verification, test and measurements

After design, construction and completion of a shielded room or installation of a cabinet it is vital to check that the shield itself has obtained the designed and required shielding effectiveness. This is normally done in two steps; first a careful visual inspection followed by a set of tests and control measurements.

Normally such tests are performed according to standards like IEEE std. 299-2006 [3], MIL-STD-285 or similar; as CW or pulse tests. These standards describe uniform test methods and procedures; included recommended test frequencies, instruments, antennas etc. The test frequencies ranges from 9kHz to 20GHz (18GHz); expandable down to 50Hz and up to 100GHz. The measurement range is divided into three subranges;

- Low frequency range 9 kHz-16MHz; magnetic field
- Resonant range ("mid range") 20MHz-300MHz; electrical field
- High frequency range 300MHz-18GHz; plane waves

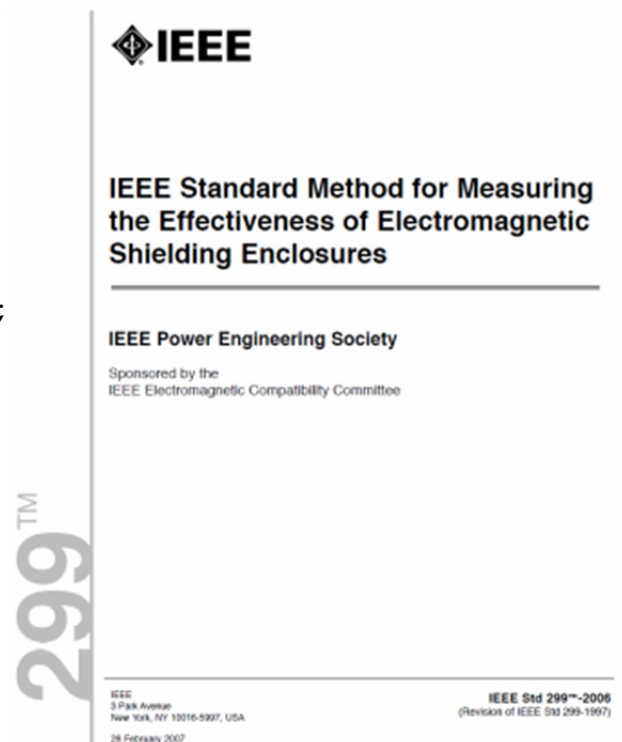

It is recommended to test a shielded room in two steps; first time after completion of the room construction and finally after full installation of technical equipment with

cabling, racks etc. The first step will validate if the shield continuity is maintained and constructed correctly without holes, gaps etc. as a result of high quality assembly. The final step will reveal wrong or poor installation of cables and tubes in Single Entry, wrong fixing or installation of equipment on walls, roof etc.

The drawings in fig. 17-18 below show principal test method for shielded enclosures (with filters) and cabinets. Some following photos show typical test instruments and antennas and practical testing of such rooms and cabinets.

Fig. 17 | Principal test method for measurement of shielded enclosures/rooms

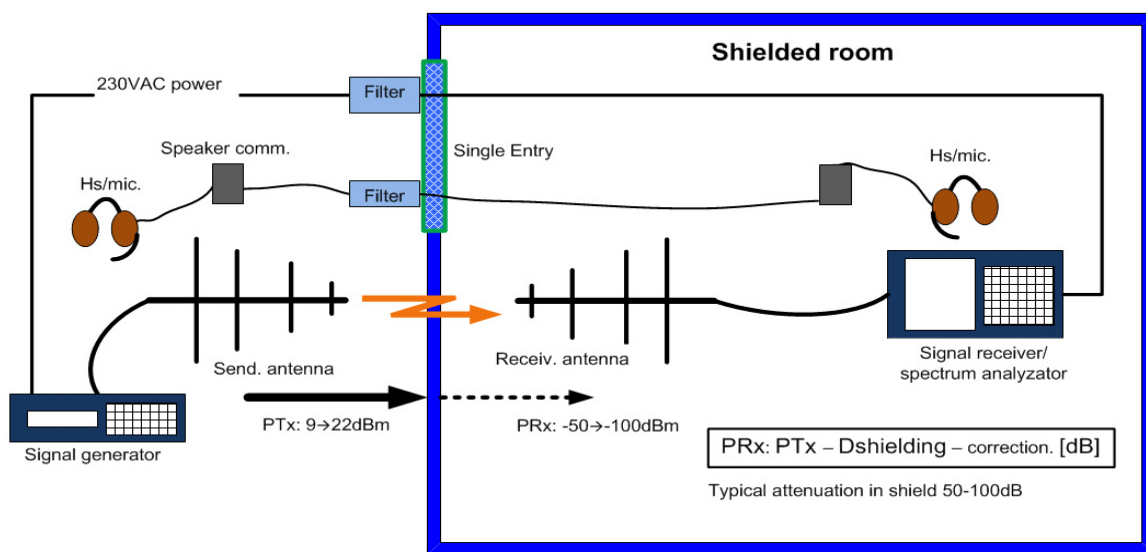
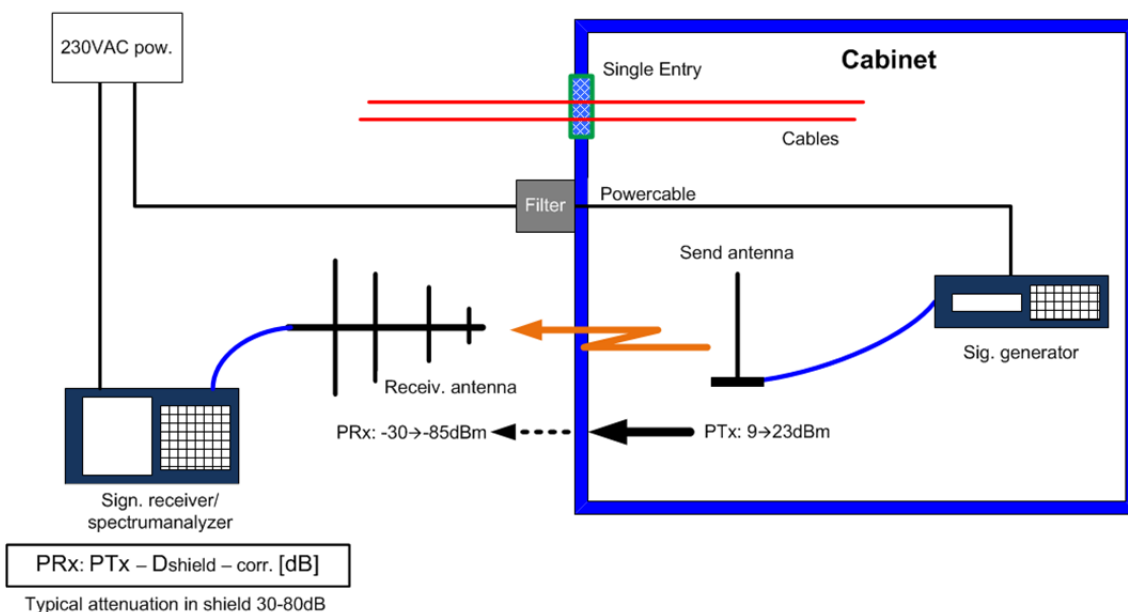
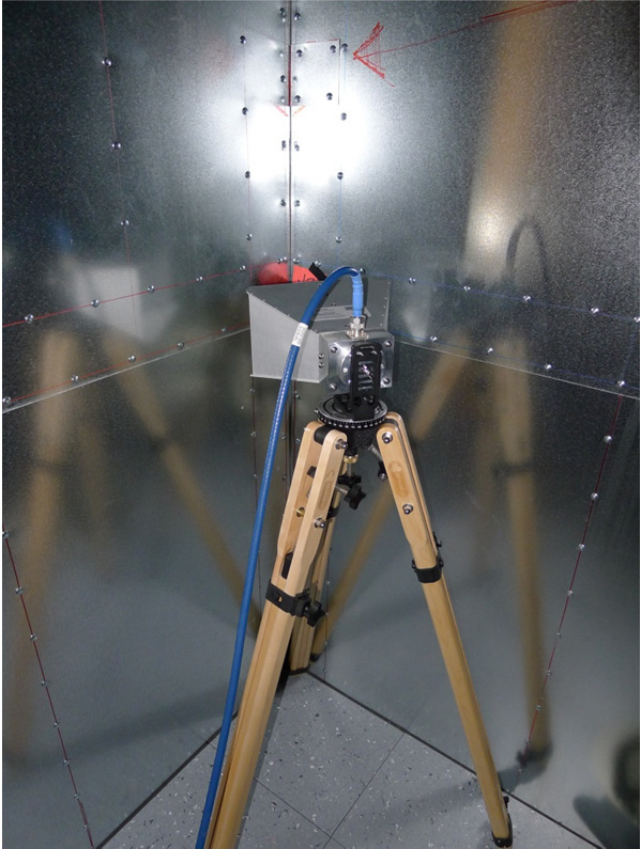
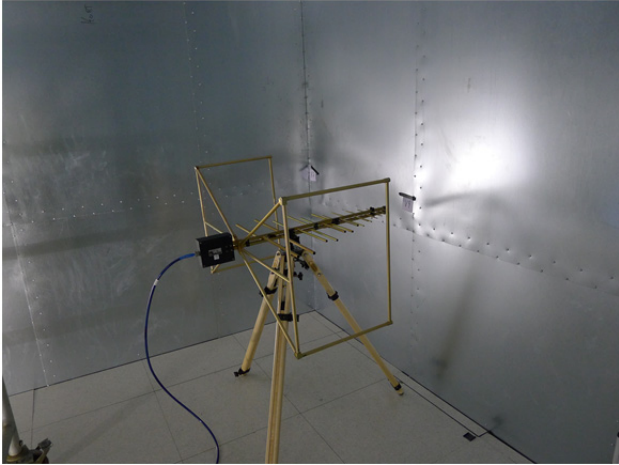
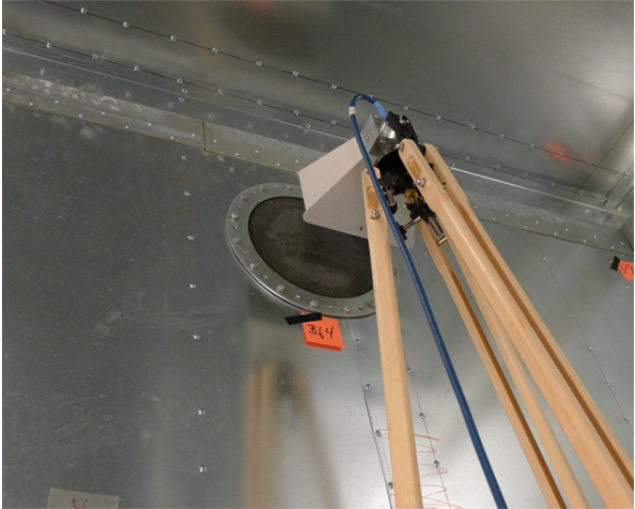
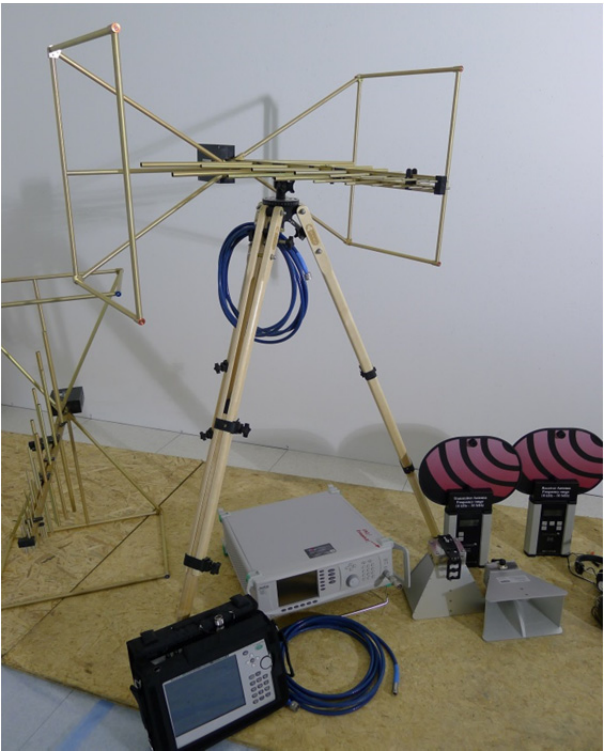

Fig. 18 | Principal test method for measurement of shielded cabinets



Photos from testing of shielded rooms





Photos from testing of shielded cabinets



7. Construction, knowledge and competence

Construction and completing of shielded rooms is normally a process involving several parties like consultants, entrepreneurs, installer companies and special dedicated consultants for final test and control measurements. Common for all these parties is demand of sufficient competence, knowledge and experience to secure high quality performance and shielding effectiveness.



According to the Authors experience the competence about EMP/EMI in general, the threats, construction and building of shielded enclosures is varying and often very limited. Thus normally this requires training of the involved parties both in the planning phase (consultants) and later on in the construction phase.

Experiences during years of managing such projects highly prove the importance of sufficient knowledge and competence to avoid poor quality in the construction phase and subsequent degraded shielding effectiveness.

8. Documentation

A project dealing with shielded room construction or purchases and installation of cabinets etc. is not completed before all necessary documents are prepared and updated as built. Needed documents are solution descriptions, drawings, manuals; all collected in documents for Management Operation and Preventive Maintenance (MOM) and test reports. Typical recommended topics are;

- Technical description of shielded room or cabinet
- Technical spec. and manuals for materials and equipment
- Photos and drawings
- Instructions for control and maintenance of actual elements and equipment; including check lists and maintenance plan

9. Reference documents

[1] Wikipedia

[2] "Regulations and requirements for EMP/EMI protection in power and grid operational control systems"; The Norwegian Water Resources and Energy Directorate; FOR 2012-12-07-1157

[3] "IEEE 299-2006 - Standard Method for Measuring the Effectiveness of Electromagnetic Shielding Enclosures"

[4] Test reports from shielded rooms and cabinets; EB Consulting as

[5] MOM documents for shielded rooms and cabinets; EB Consulting as

[6] Photo archive and drawings; EB Consulting as

Kristiansand 26.6..15



Lian Platå 51

N-4638 Kristiansand

Norway

Mobile: +47 90678148

Email: post@eb-c.no

www.eb-c.no